



Section 9:

Washer Parts

SWD C-Series Accessories T-450

Key	Description	Part Number	Qty
*	Hose, Water Supply 3/8" I.D.	9990-027-011	2
*	Washer, Inlet Hose (furnished)	8641-242-000	2
*	Strainer, Inlet Hose (furnished)	9565-003-001	2
*	Sealing compound	8538-151-002	1
*	TORX#20 Driver	8545-051-002	1
*	Special Tool For Removing Coin Acceptor Mounting Screws. (T-10 Torx)	8545-051-003	1
*	Flow Restrictors (in dispenser)	9475-002-003	3
*	Battery 3V Lithium (used on Control PCB)	8612-001-001	1
*	Coin Bearing & Seal Kit	9732-219-005	1
*	Mode Light Support	9635-022-001	1

Wiring Harnesses Parts

Key	Description	Part Number	Qty
1	Wiring Harness, Door Lock P15/P4	9627-816-002	1
*	Wiring Harness, Coin Drop	9627-916-001	1
2	Wiring Harness, Drain,Thermo,Door Gear Motor P17	9627-820-002	1
3	Data Cable	9806-015-002	1
4	Cableassy-USB	9806-022-001	1
*	Retainer-USB	9486-159-001	1
5	Wiring Harness P20/P21	9627-818-002	1
6	Wire Harness-program switch	9627-910-002	1
7	Wiring Harness P8/P16	9627-819-001	1
8	Wiring Harness Water Valve/P19	9627-795-004	1
9	Wiring Harness LED PCB	9627-821-001	1
*	Harness Power Terminal Block	9627-747-003	1
*	Wire Yellow Jumper (water valve)	8220-123-001	1
10	Harness-Extention, Transformer	9627-826-001	1
11	Harness-P5/Pressure Switch	9627-908-006	1
*	Circuit Breaker 7 AMP	5198-211-002	1
*	Wiring label-schematic/diagram	9506-827-001	1

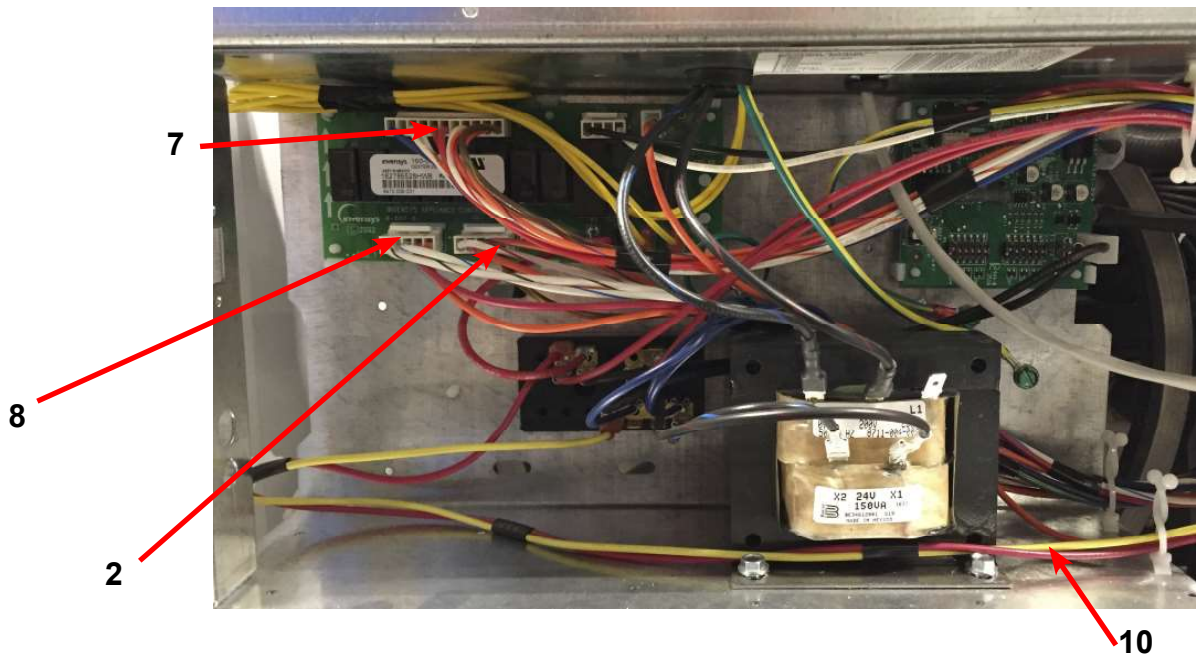
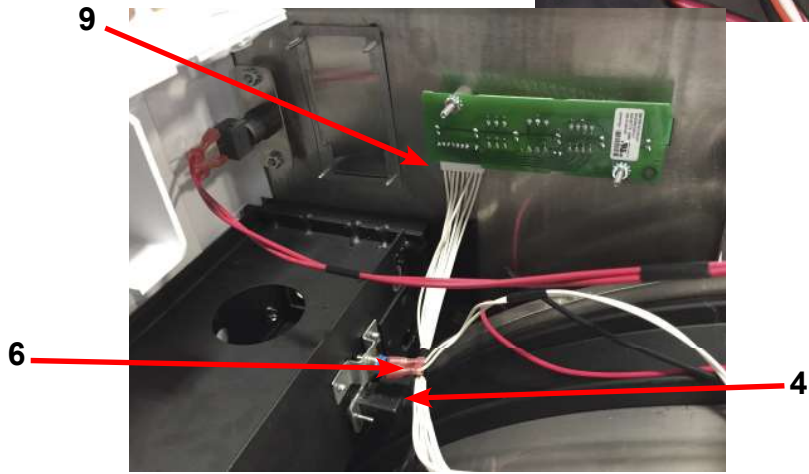
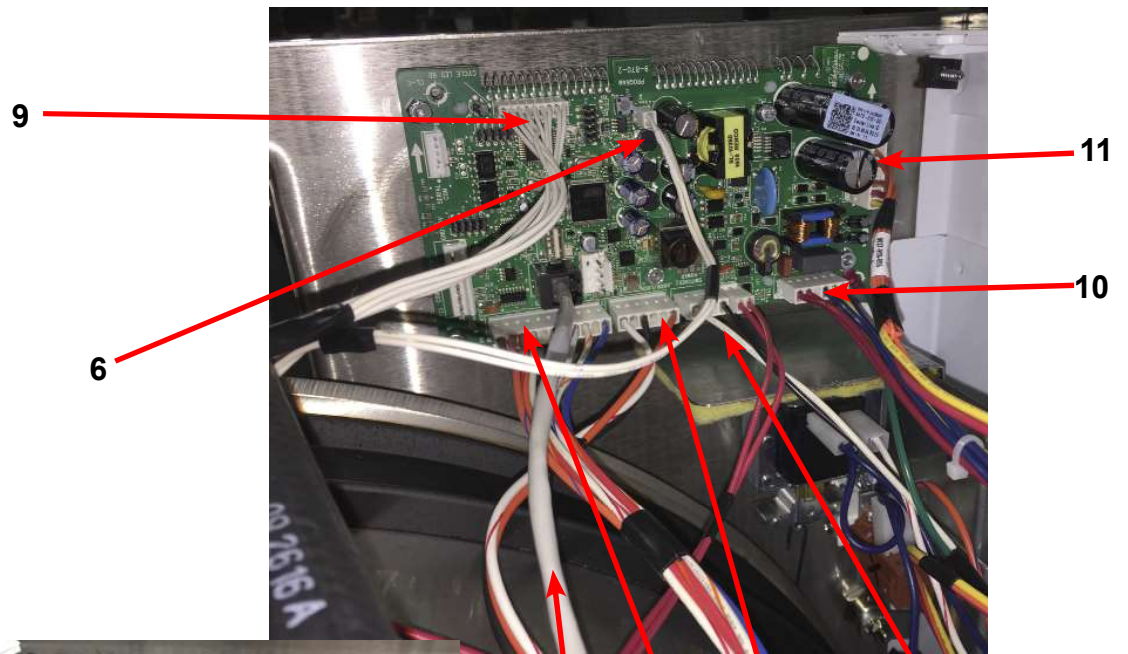

WCS450XA Rear View Access Parts Group

Key	Description	Part Number	Qty
1	Drive Motor, 3 Phase (Inverter duty)	9376-319-001	1
2	Rod, Motor Mtg	9497-222-006	1
3	Motor Bushing (Rubber)	9053-082-001	2
*	Clamp-Worm, 316SS, 1.5" (for Rubber bushing)	8654-117-019	2
4	Strap Bracket, Motor Tension	9029-206-002	1
*	Nut, Strap to Motor	8640-413-002	1
*	Washer	8641-581-006	1
5	Spring, Belt Tension	9534-319-002	1
*	Pulley, Motor	9453-170-003	1
*	Set Screw,Sq.Hd(motor pulley)	9545-028-015	2
*	Tolerance Ring	9487-234-003	1
6	Pulley, Driven	9453-168-003	1
*	Screw 5/8-11x1/2"	9545-060-001	1
*	Lockwasher 5/8"	8641-582-018	1
*	Washer, Flat 5/8x2 1/4"	8641-581-032	2
7	Drive Belt	9040-077-003	2
8	Channel, Rear	9081-190-001	1
*	Screw	9545-008-026	4
*	Nut, Spring	8640-399-001	4
*	Hose, Overflow to drain	9242-449-004	1
*	Clamp, Hose overflow to drain	8654-117-009	2
9	Hose, Overflow Vent Top	9242-463-005	1
*	Clamp, Hose Vent	8654-117-014	1
10	Vacuum Breaker ALL	9610-001-001	1
11	Bracket, Vacuum Breaker	9029-121-001	1
12	Screw, 10B x 1/2	9545-008-026	4
*	Vacuum Breaker Cap	0935-135-002	*
13	Hose, Vacuum Breaker to tub	9242-458-001	1
*	Plastic Plug 7/8" Electrical Connection	9456-041-006	1
*	Panel Assy., Back	9454-966-001	1
*	Screw Panel Mtg.#10Bx1/2"	9545-008-026	10
*	Screw Panel Mtg.#1/4Bx3/4"	9545-030-002	3
*	Nut, Spring	8640-399-001	8
14	Hose, Pressure Switch	9242-175-005	1
*	Clamp, Pressure Switch Hose	8654-117-015	1
15	VFD Delta "E" drive 208-240 volt	9375-035-004	1
*	Braking resistors (200 ohm)	9483-044-002	2
16	Bracket assembly (drive mounting)	9029-119-002	1

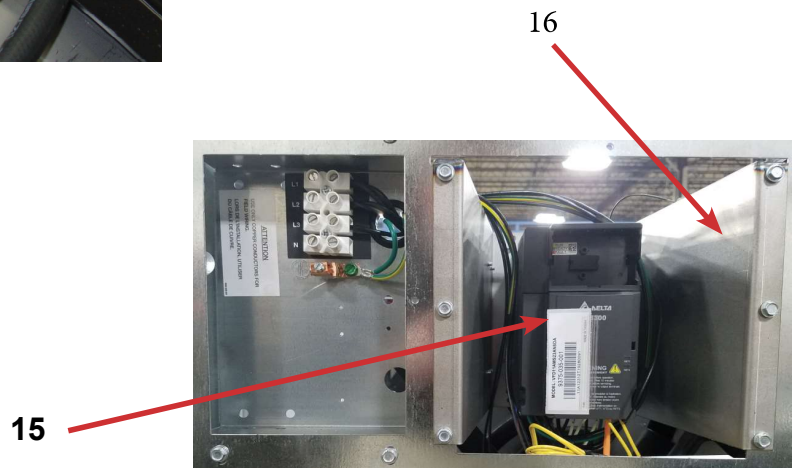
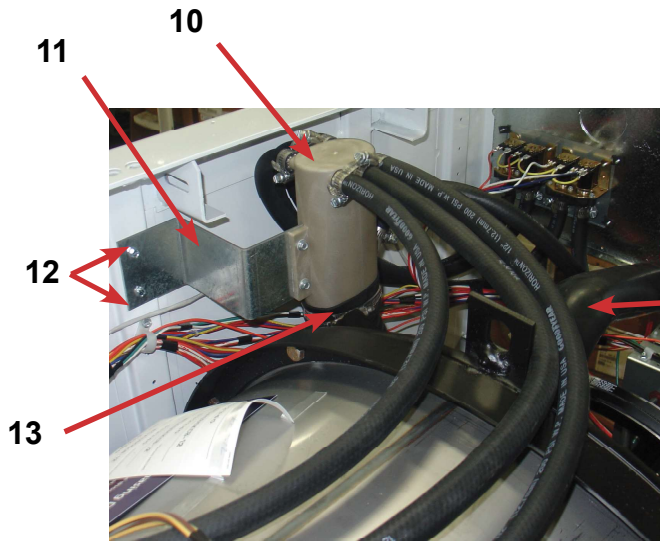
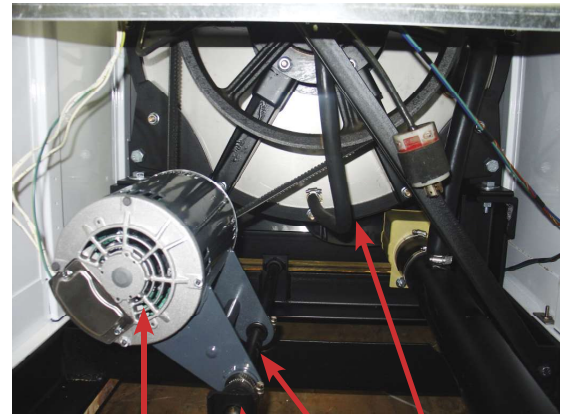
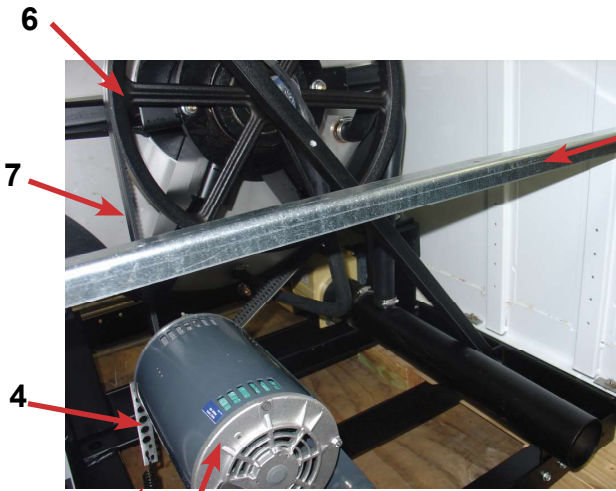

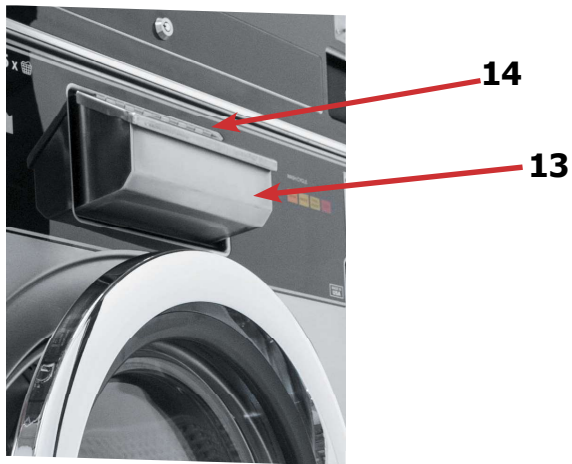
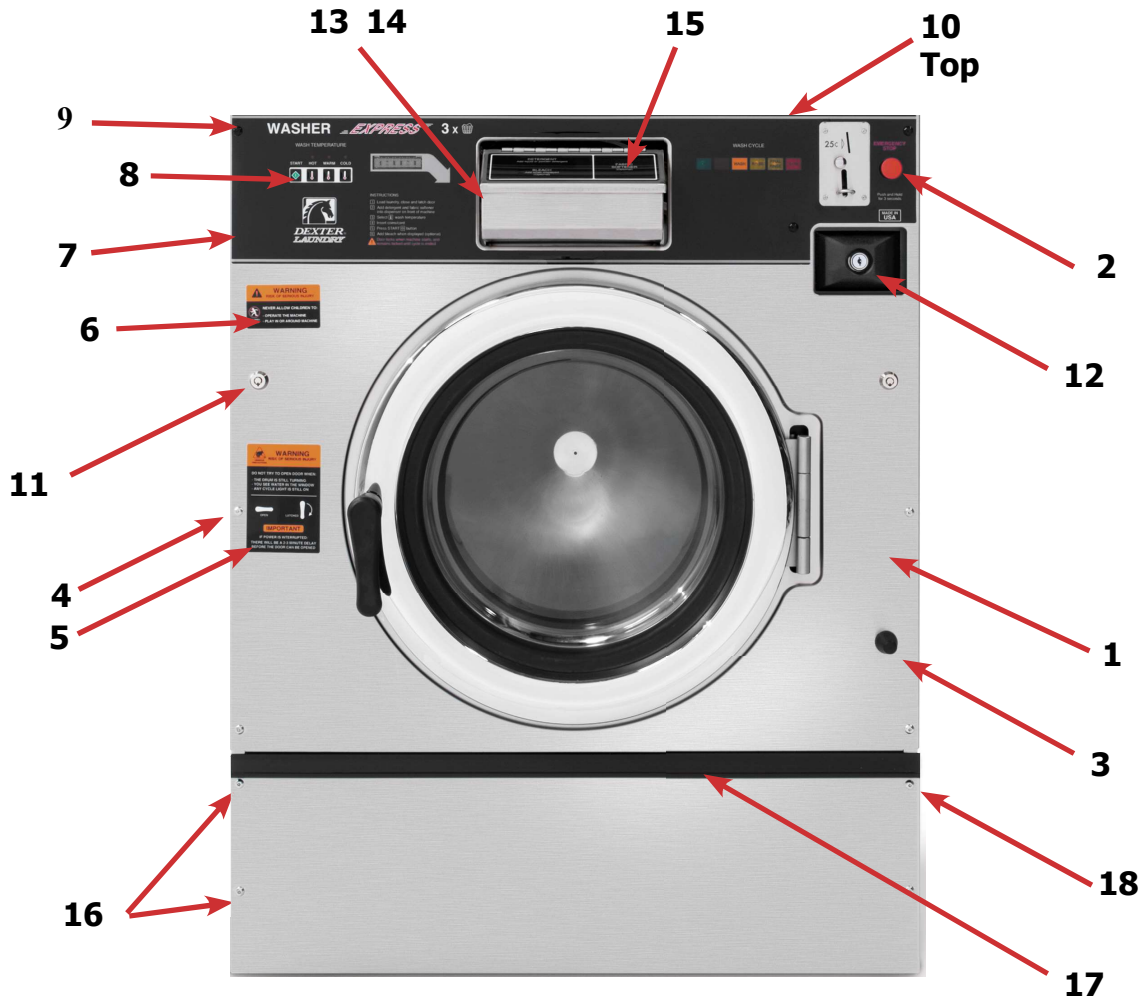

WSC450XA Cabinet and Front Panel Group

Key	Description	Part Number	Qty
*	Panel, Right Side-Painted	9989-604-002	1
*	Panel, Left Side - Painted	9989-605-002	1
*	Screw	9545-018-023	8
1	Panel Assy, Front	9989-606-001	1
2	Switch Assembly, Stop Button Kit	9732-223-002	1
*	Stop Button Mounting Plate	9452-725-001	1
3	Bumper Loading Door	9051-055-001	1
4	Screw, Torx Head- 10AB x 3/4,	9545-008-020	4
*	Nut, Spring-To Front Panel	8640-399-001	4
5	Label, Door Opening, Blue	8502-757-002	1
5	Label, Door Opening, Black	8502-757-001	1
6	Label, Risk of Injury, Blue	8502-759-002	1
6	Label, Risk of Injury, Black	8502-759-001	1
7	Nameplate Decal, Control Panel, Blue	9412-205-002	1
7	Nameplate Decal, Control Panel, Black	9412-205-001	1
8	Button, Push Control, Blue	9035-060-003	1
8	Button, Push Control, Black	9035-060-005	1
9	Screw, Torx Head- 10AB x 3/4, Blue	9545-008-009	2
9	Screw, Torx Head- 10AB x 3/4, Black	9545-008-036	2
10	Panel, Front, Painted	9989-608-002	1
*	Screw, Hex, #10B x 1/2	9545-008-026	8
*	Panel Top Rear	9454-965-001	1
*	Screw, Hex, #10B x 1/2	9545-008-026	6
11	Lock, (w/Key)	8650-012-003	2
*	Key, - # 6324	6292-006-007	1
*	Cam, Lock-	9095-050-001	2
*	Nut, 9/32 - 28 Hex	8640-426-001	2
*	Washer Flat 5/16	8641-581-008	2
*	Coin Vault Assy, Coin	9942-028-003	1
12	Coin Box, Blue	9807-099-001	1
12	Coin Box, Black	9807-099-003	
13	Soap Dispenser Assembly, Complete (Does not include lid)	9807-087-001	1
*	Soap Box mounting Gasket	9206-425-001	1
14	Lid Assembly soap box	9987-104-001	1
*	Lid screws #10-32x1/2 SS	9545-012-017	2
*	Nut Hex Elasticstop #10-32 SS	8640-413-006	6
*	Bracket Soap box mounting	9029-122-002	1
*	Softener siphon tube (plastic)	9574-252-002	1
*	Flow restrictors	9475-002-003	3
15	Label, Dispenser Instructions, Blue	8502-756-002	1
15	Label, Dispenser Instructions, Black	8502-756-001	1
16	Door, Lower Service Assembly	9960-286-009	1
17	Handle, Lower Service Door	9244-086-005	1
18	Screw, Torx Head- 10AB x 3/4,	9545-008-020	4

WSC450XA Cylinder, Seals & Bearings

Description		Part Number	Qty
*	Housing, Bearing- Assembly (items #2-#6)	9803-186-001	1
2	Housing, Bearing	9241-180-002	1
3	Bearing, Front (LARGE)	9036-159-005	1
4	Bearing, Rear (SMALL)	9036-159-004	1
5	Spacer, Bearing	9538-167-001	1
6	Ring, Bearing Retainer	9487-238-003	1
8	Seal, Primary	9532-140-006	1
9	Seal, Secondary	9532-140-009	1
10	Ring, Seal Mounting	9950-048-001	1
11	Tub Back Mating Ring	9487-261-003	1
12	Bolt 5/8-11x1 1/2" Tub end of bearing Housing	9545-060-001	6
12	Nut 5/8"-11	8640-425-001	6
13	Support Arm Assy, Bearing Housing	9991-056-002	6
14	Bolt Pulley end of bearing housing, 7/16-14x2"	9545-059-003	6
*	Nut, Flange Locking 7/16"	8640-416-005	6
15	Pulley, Driven	9453-168-003	1
16	Ring, Tolerance	9487-234-003	1
17	Washer 5/8"x 2 1/4"	8641-581-032	2
18	Bolt 5/8-11x1 1/2"	9545-060-001	1
19	Lockwasher 5/8 Ext. tooth	8641-582-018	1
*	Cylinder Assy	9848-120-001	1
*	Tub and Cylinder Assy.	9869-034-001	1
*	Plastic Plug 1 1/2"-(inside cylinder)	9456-041-007	1

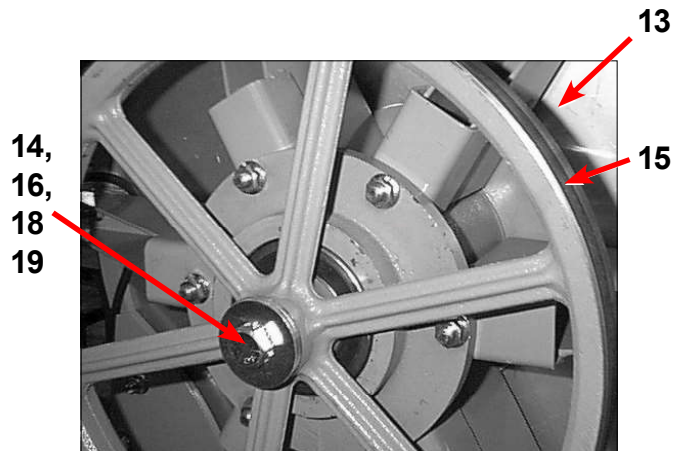
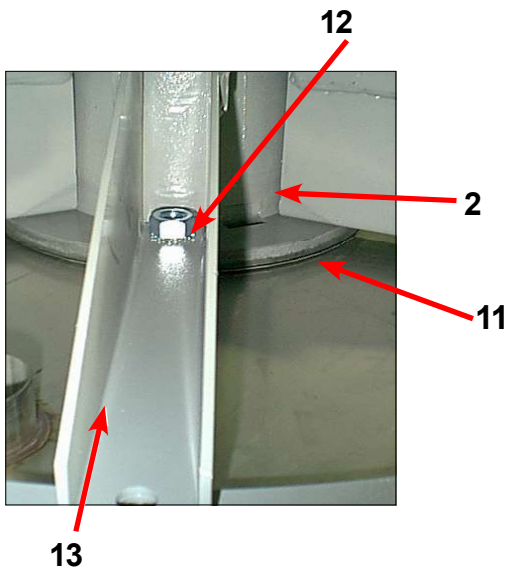
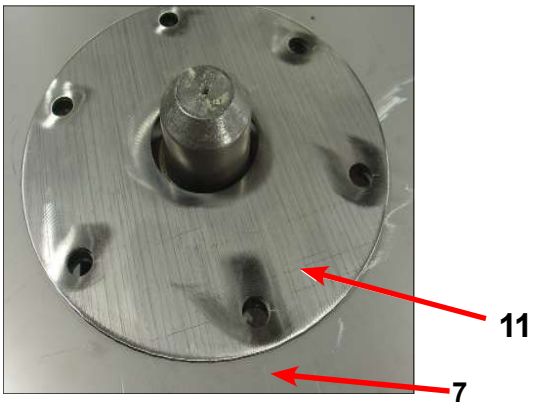
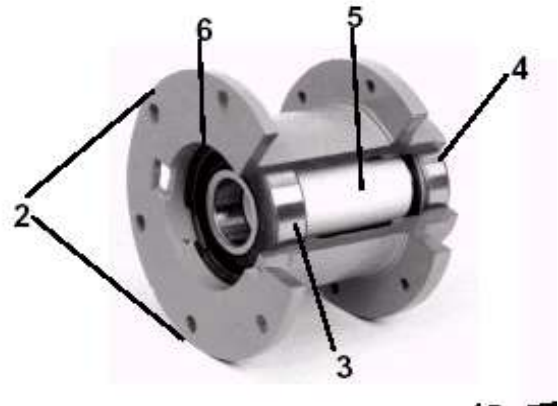
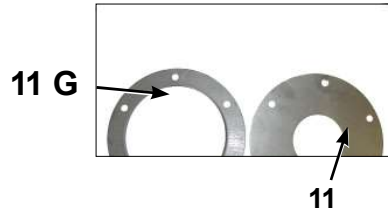
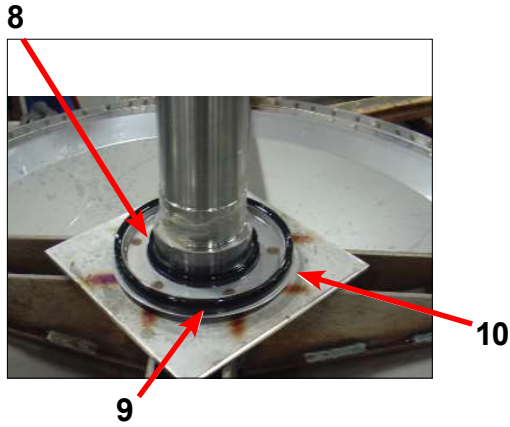
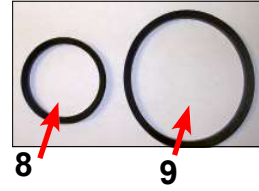
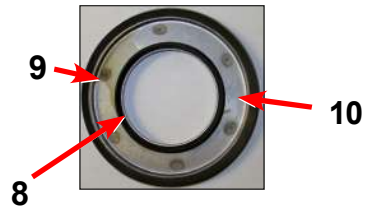

Door Lock Assembly (continued)

Key	Description	Part Number	Qty
33	Lock Assy, Complete (#1-22)(includes #1 thru #22)	9885-024-001	1
1	Plate Assy, Door Lock	9982-346-001	1
2	Washer, Flat	8641-581-030	1
3	Actuator, Latching Switch	9008-005-001	1
4	Pawl, Locking	9450-003-002	1
5	Washer, Spring	8641-569-003	1
6	Ring, Retaining	9487-200-004	1
7	Bracket Switch	9029-163-001	1
8	Nut, Hex 10-32 UNF	8640-413-002	2
9	Spring, Actuating	9534-364-002	1
10	Screw, Hx. 10-32 x 1"	9545-012-020	1
11	Nut, Elastic Stop 10-32	8640-413-004	2
12	Spring, Return	9534-364-001	2
13	Pin, Guide	9451-193-001	1
14	Ring, Retaining	9487-200-005	1
15	Washer	8641-581-031	1
16	Switch, Latching Sensing	9539-461-008	1
17	Shield, Switch	9550-169-003	3
18	Screw 4-40 x 5/8"	9545-020-001	2
18	Nut, Twin	8640-401-001	1
19	Switch, Locking Sensing	9539-461-007	2
20	Actuator, Switch Locking	9008-006-003	1
21	Screw 4-40 x 1 1/8"	9545-020-003	2
21	Nut, Twin 4-40	8640-401-001	1
*	Shim, Door Lock, Thin	9552-037-001	AR
*	Screw, Lock mtg 1/4"-20 x 3/4"	9545-018-014	3
*	Lockwasher 1/4" Ext tooth	8641-582-007	3

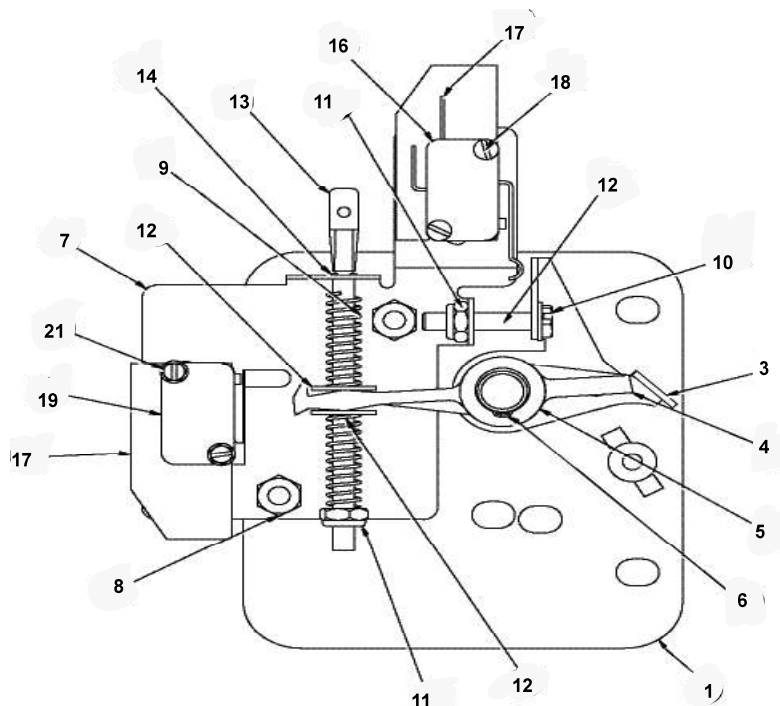

Gear Motor Door Lock Assembly

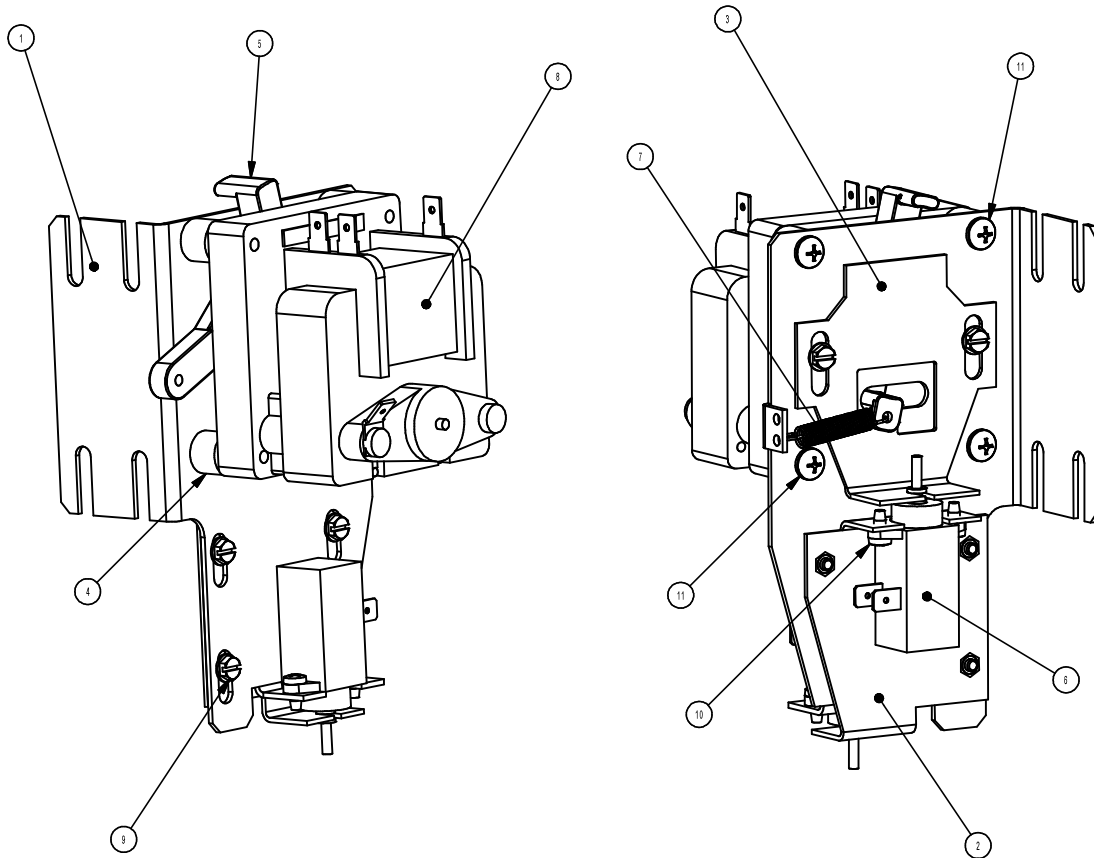

Key	Description	T-450	QTY
*	Actuator Assembly (Includes 1-10, Rod NOT included)	9892-017-002	1
1	Bracket Assy, Slide Lock Actuator	9985-199-001	1
2	Bracket Assy, Slide - Unlock	9985-196-001	1
3	Bracket Slide Lock	9029-278-001	1
4	Spacer, Plastic	9538-157-021	4
5	Arm - Door Lock	9001-063-001	1
6	Thermoactuator - Door Lock Relay 24VAC	9586-001-003	2
7	Spring - Extension	9534-350-001	1
8	Motor & Gear Assembly 24VAC	9914-137-014	1
9	Screw -Hxwshrhdslsems, 6-32 x 3/16	9545-044-003	6
10	Cross Recessed PAn Hd Tapping screw	9545-031-011	4
11	Screw Pnhdcr, 10-32 UNFx0 .75	9545-012-029	4
12	Standoff-Wire	9527-007-001	1
*	Rod, Door Lock	9497-225-018	1
*	Harness, Door Lock/Drain, P17	9627-820-002	1

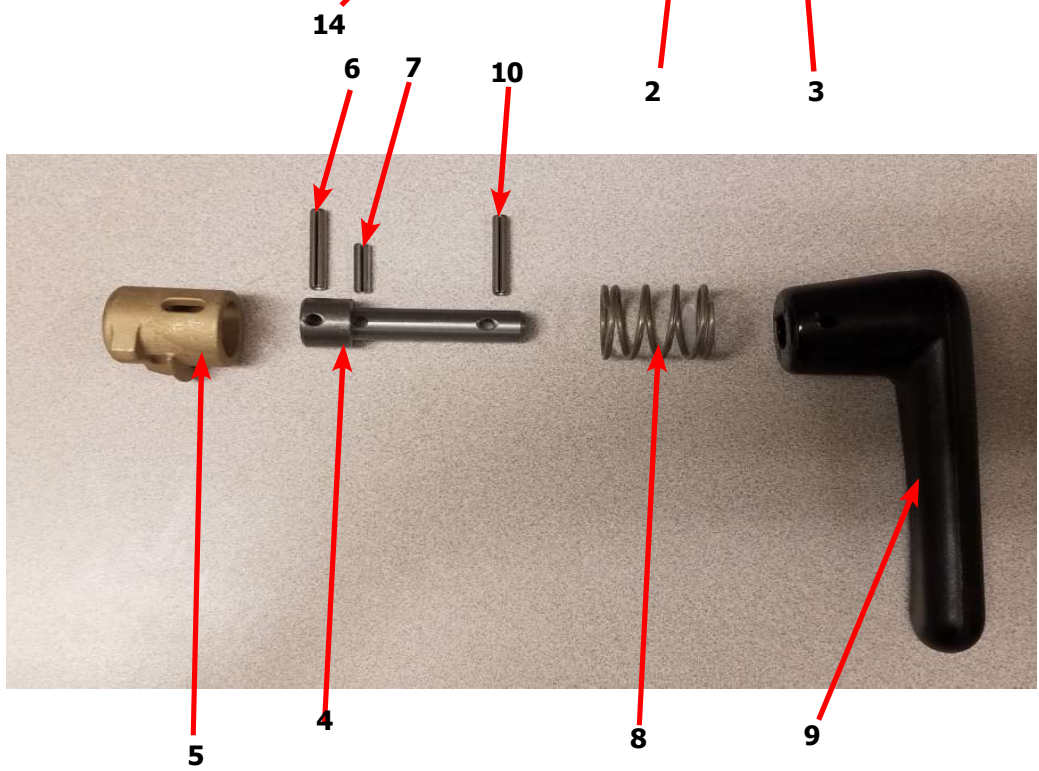
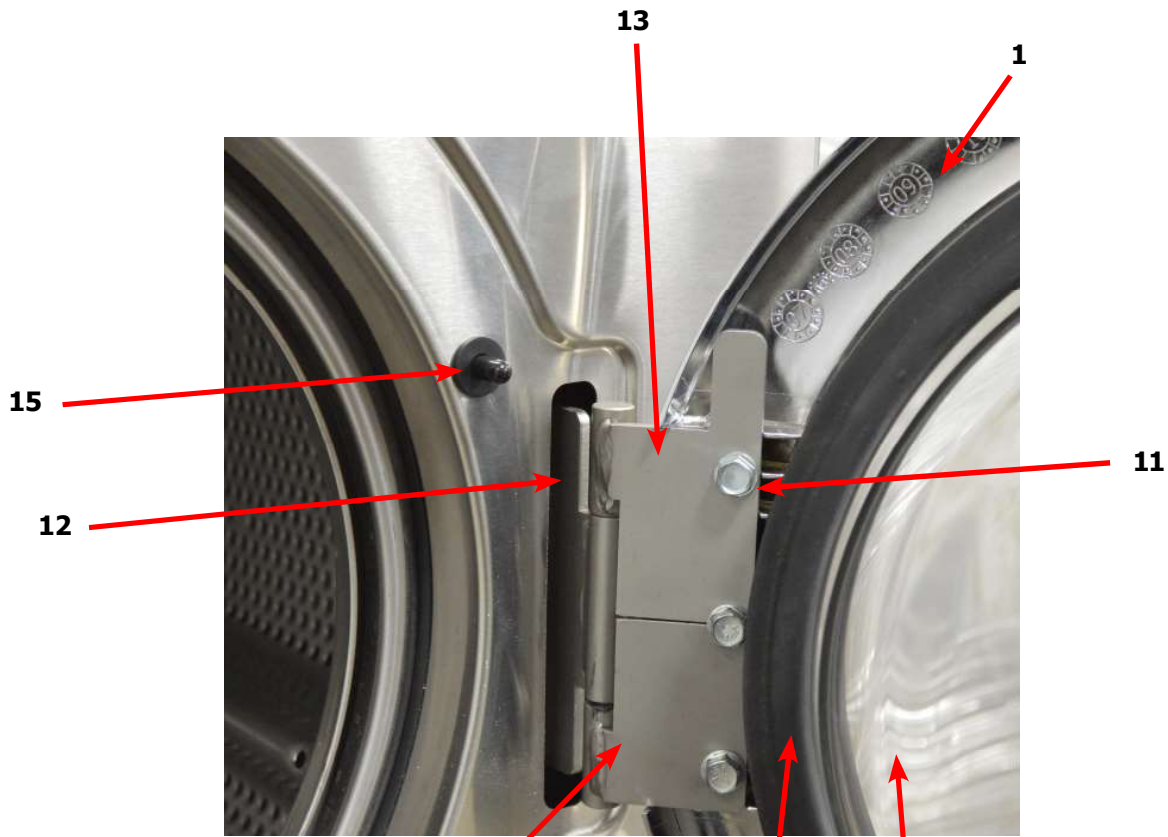

WCS450XA Loading Door Group Part

Key	Description	Part Number	Qty
	Loading Door, Complete #1-10	9960-309-001	1
1	Loading Door, Ring (180 Degrees)	9487-265-002	1
2	Gasket, Loading Door	9206-419-001	1
3	Window, Loading Door	9635-016-001	1
*	Shaft Assy, Locking (includes 4 thru 7)	9913-134-003	1
4	Shaft, Door Locking	9537-195-002	1
5	Cam, Locking	9095-040-002	1
6	Pin, Groove (1 1/4)	9451-181-005	1
7	Pin, Groove (3/4)	9451-181-004	1
8	Spring, Lock Cam	9534-360-002	1
9	Handle, Door	9244-091-001	1
10	Pin, Door Handle (groove)	9451-181-005	1
11	Screw, Loading Door Mtg (5/16" TF)	9545-056-002	3
*	Shim, Loading Door Hinge, Thin	9552-037-001	1
12	Door Hinge Assembly Mounts to Tub Front	9955-030-001	1
*	Screw, Hinge Mtg 5/16" -18x 3/4"	9545-014-009	3
*	Lockwasher 5/16" Ext tooth	8641-582-009	3
*	Wiring Harness doorlock safety Switch Assembly	9627-816-002	1
*	Wire Assembly Door Close Switch, Red 17"	8220-063-025	1
*	Wire Assembly Door Close Switch, BLK 17"	8220-063-026	1
13	Leaf assembly, Hinge Top	9845-008-001	1
14	Leaf assembly, Hinge Bottom	9845-005-002	1
15	Switch Door Closure	9539-492-001	1

Drain Valve Group Part # by Model

Key	Description	Part Number	Qty
1	Valve, Drain (includes #2 thru #11)	9379-202-002	1
2	Body, Valve (w/ball)	9064-072-001	1
3	Motor & Gear Train (complete)	9914-137-022	1
4	Plate, Motor Mtg	9452-538-001	1
5	Screw	8639-994-001	1
6	Spring, Drive	9534-339-001	1
7	Screw	9545-054-001	1
8	Screw	9545-054-002	1
9	Seal, V Packer	9532-134-001	1
10	Washer	8641-584-001	1
11	Pin, Main Drive	9451-196-001	1
*	Plate (spacers needed for replacement motor mtg. plate)	9538-149-001	1
12	Kit - Seal Replacement	9732-327-001	1

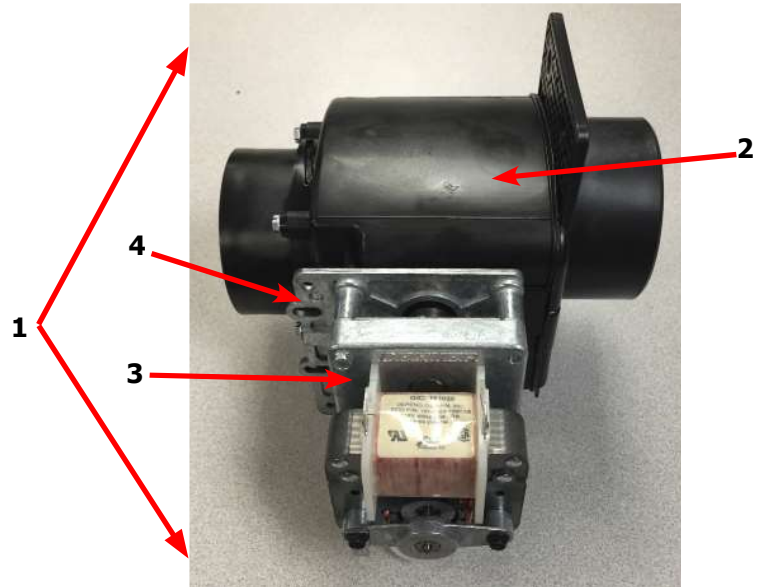

9, 10, 11

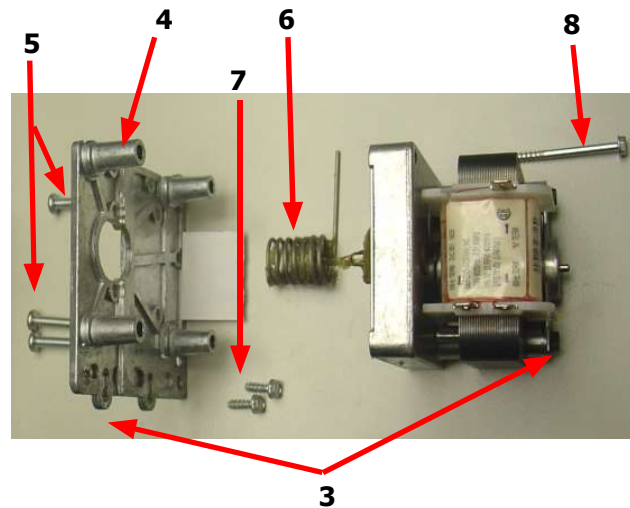

Water Inlet Valve Breakdown

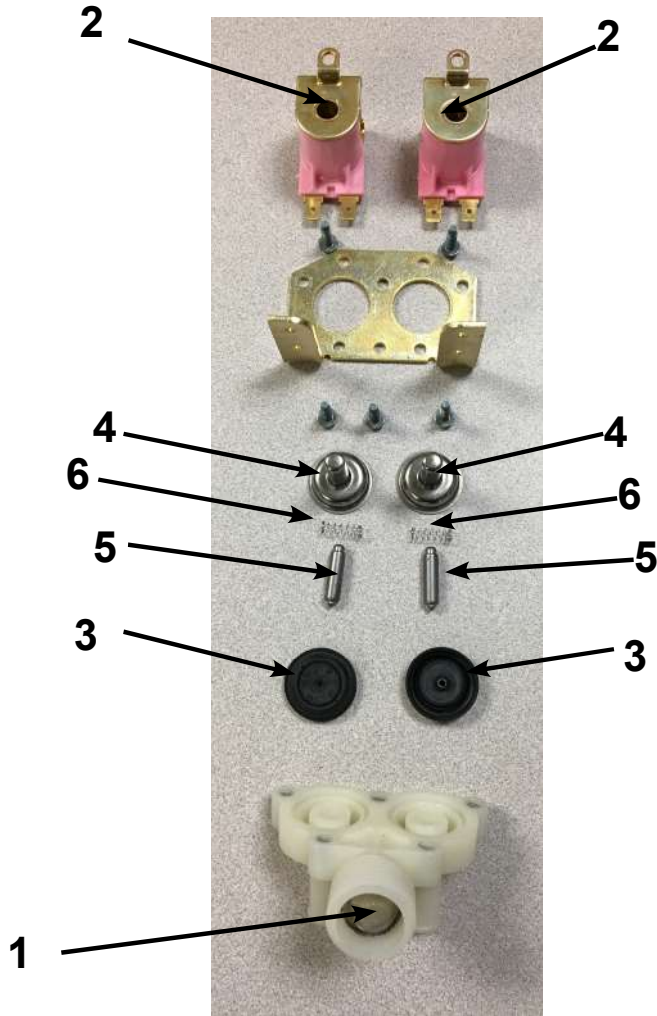

Key	Description	Part Number	QTY
*	Valve, Water Inlet (includes 1 thru 6) - Invensys	9379-183-013	2
1	Screen, Inlet end of valve	9555-056-001	2
2	Coil Assy., 24 V Invensys	9089-017-004	2
3	Diaphragm Invensys (EPDM)	9118-049-003	2
4	Guide, Solenoid Invensys	9211-021-002	2
5	Armature Invensys	9015-008-001	2
6	Spring, Armature Invensys	9534-298-001	2

WCS450XA Chassis and Drain by Part

Key	Description	Part Number	Qty
1	Base Assy,Frame	9945-150-002	1
*	Outer Tub Assy	9930-166-001	1
*	Cylinder Assembly, (Includes Spider)	9848-120-001	1
3	Back Assy, Tub	9962-013-003	1
4	Bolt, 7/16" x 2" Tub Back to Tub	9545-059-002	12
5	Nut, Flange Lock	8640-416-005	12
*	Bolt, 5/8-11 x 1 1/2 Tub to Base, Front	9545-060-001	2
*	Nut, 5/8-11 Wizlok	8640-425-001	2
*	Ring Assy, Tub Mtg-Front	9950-051-004	1
*	Bolt, Top Front Ring 5/8" x 3"	9545-017-016	1
*	Nut 5/8"	8640-417-005	1
6	Ring Assy.Clamp Tub Mtg.- Rear	9950-056-002	1
7	Bolt, 5/8-11 x 1 1/2 Tub to Base, Rear	9545-060-001	2
8	Nut, 5/8-11 Wizlok	8640-425-001	2
9	Bolt, 5/8-11 x 2 Tub & Rings to Base, Front & Rear	9545-060-004	4
10	Washer	8641-581-038	4
11	Nut, 5/8-11 Wizlok	8640-425-001	4
12	Hose, Overflow	9242-449-004	1
13	Clamp	8654-117-018	2
14	Tube, Over Suds	9242-463-005	1
*	Clamp	8654-117-014	1
15	Hose, Tub to Drain Valve	9242-464-001	1
16	Valve, Drain	9379-202-002	1
*	Screw, Valve to Bracket 5/16-18x1 1/4	9545-014-012	2
*	Nut, 5/16-18	8640-400-003	2
17	Hose, Drain Valve to Tube	9242-457-001	1
*	Clamp, Hose (Drain Valve to Tube)&(Drain Hose to Valve)	8654-117-009	2
*	Screw Tube (Bracket to Base 1/4B x 3/4)	9545-030-002	2
18	Tube Assy, Drain	9915-122-002	1
19	Hose, Vacuum Brkr. to Tub	9242-458-001	1
*	Clamp	8654-117-014	2
20	Hose, Pressure Switch	9242-175-005	1

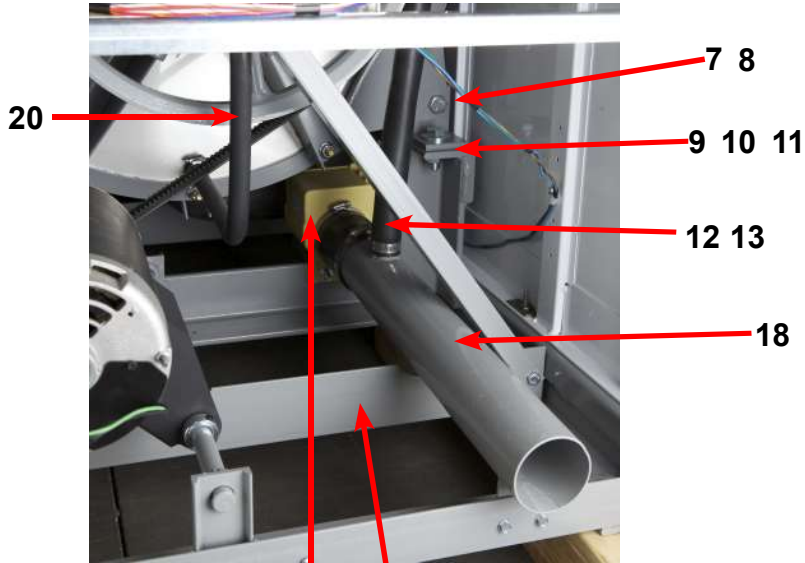

1
16

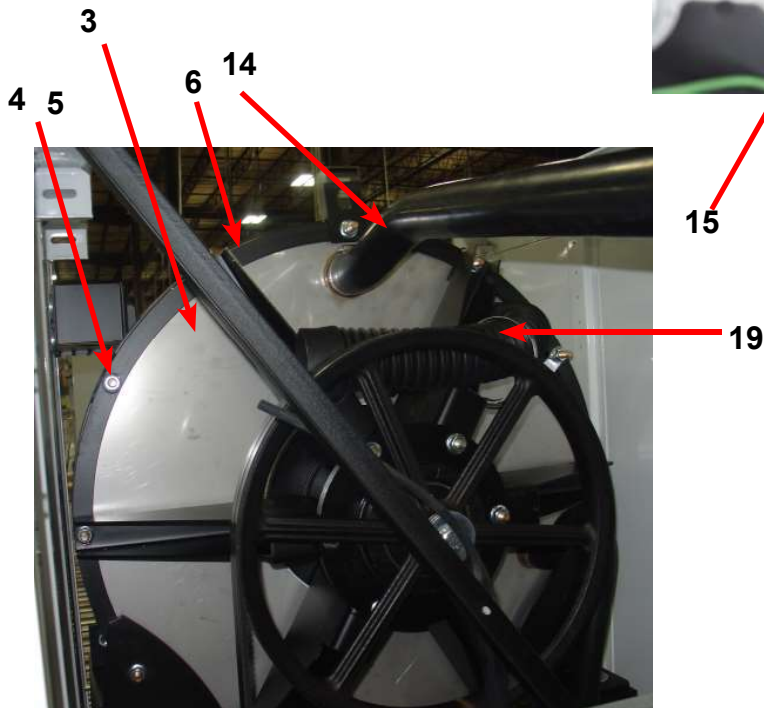
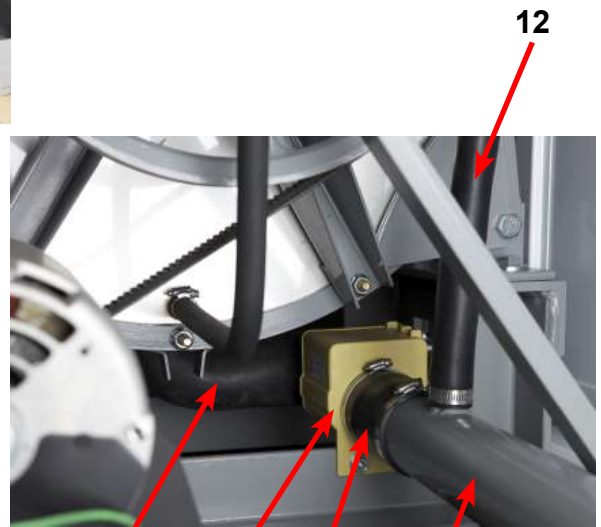

Electrical Components, Control Trough

Key	Description	Part Number	Qty
1	Trough Assy,Controls 208-240 volt	9857-235-001	1
	Trough only	9839-018-001	1
2	Transformer, Control (208/230/60 Hz In 24 VAC Out Volts)	8711-004-004	1
*	Wire Assembly, Red 28"	8220-062-025	2
*	Screw, #10B x 1/2	9545-008-026	4
*	Lockwasher Exttooth #10	8641-582-006	4
*	Wire Assembly, BLK/BLU	8220-001-231	1
*	Wire Assembly, BLK/RED	8220-001-230	1
3	Terminal Block Assy, POWER	9897-026-004	1
*	Screw, Mtg 8Bx1/2"	9545-045-012	2
*	Harness-Extention, Transformer	9627-826-001	1
*	Screw, 8B x 1/4	9545-045-001	2
*	Lockwasher-External Tooth, #10	8641-582-005	2
*	Wire Assembly, P12, Red 7"	9631-381-018	1
4	PCB assembly Relay Main	9473-006-001	1
*	PCB support 3/8 edge Holding	9548-285-001	10
*	Wiring Harness, Door Lock P15/P4	9627-816-002	1
*	Wiring Assembly Yel. 32" P14 & P13	8220-064-023	2
5	Wiring Harness, Drain,Thermo,Door LockP17	9627-820-002	1
6	Wiring Harness Water Valve/P19	9627-795-004	1
7	Wiring Harness P8/P16	9627-819-001	1
*	Wiring Harness P20/P21	9627-818-002	1
8	Sensor-Pressure Switch	9732-315-001	1
9	Harness Assembly, Pressure Switch	9627-908-006	1
10	Wiring Harness-Main	9627-914-002	1

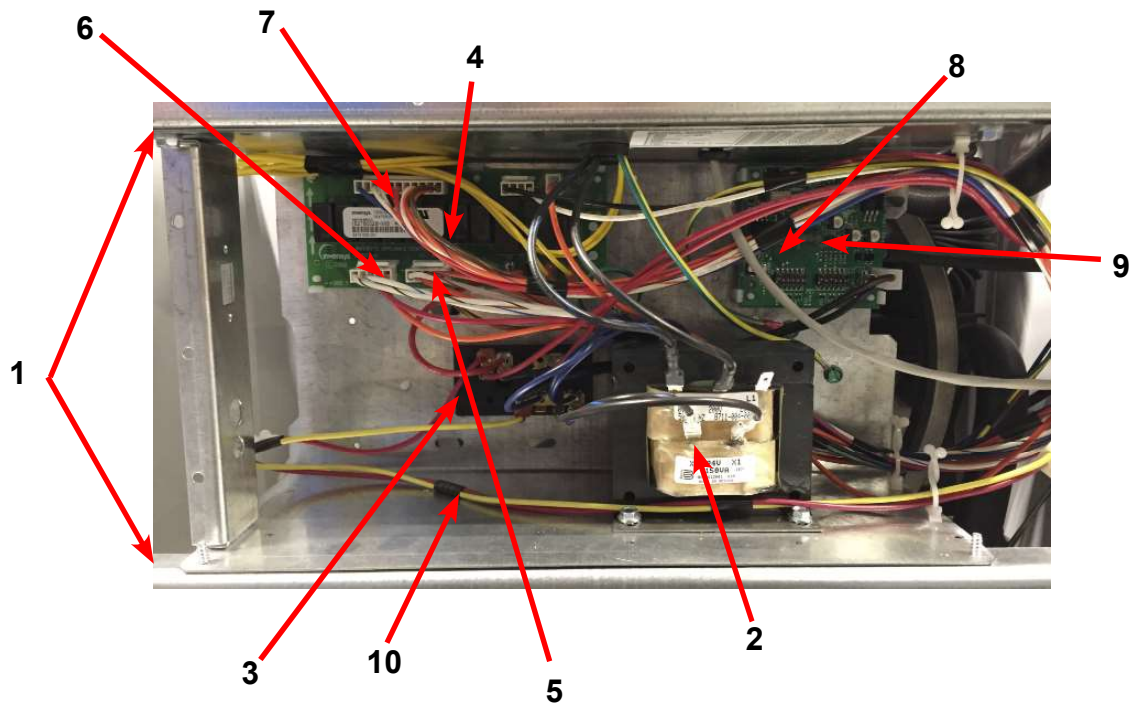

Electrical Components, Upper Channel

Key	Description	Part Number	Qty
1	Terminal Block Assy, POWER	9897-033-002	1
*	Screw, Mtg 6ABx3/4"	9495-031-010	2
2	Strip, Terminal Marker	9558-025-001	1
3	Terminal, Lug-Solderless (Ground)	8652-134-001	1
*	Screw, 10-32TTx1/2 Green (Control Trough)	9545-008-027	
*	Wiring Harness Power Terminal To VFD & Control Transformer and ground wire	9627-747-003	1
4	VFD Delta drive 208-240 volt	9375-035-004	1
*	Cable, Data Communication	9806-025-002	1
*	Wiring Assembly Yel. 32"	8220-064-023	2
5	Braking resistors (160 ohm)	9483-004-002	2
*	Wire Assembly-Jumper, BLK (Breaking Resistors)	8220-117-002	2
*	Label Fusing and Installation 7 amp Rear	8502-619-004	1
6	Circuit Breaker 7 AMP	5198-211-002	1
*	Plate Mounting water valves	9452-691-001	1

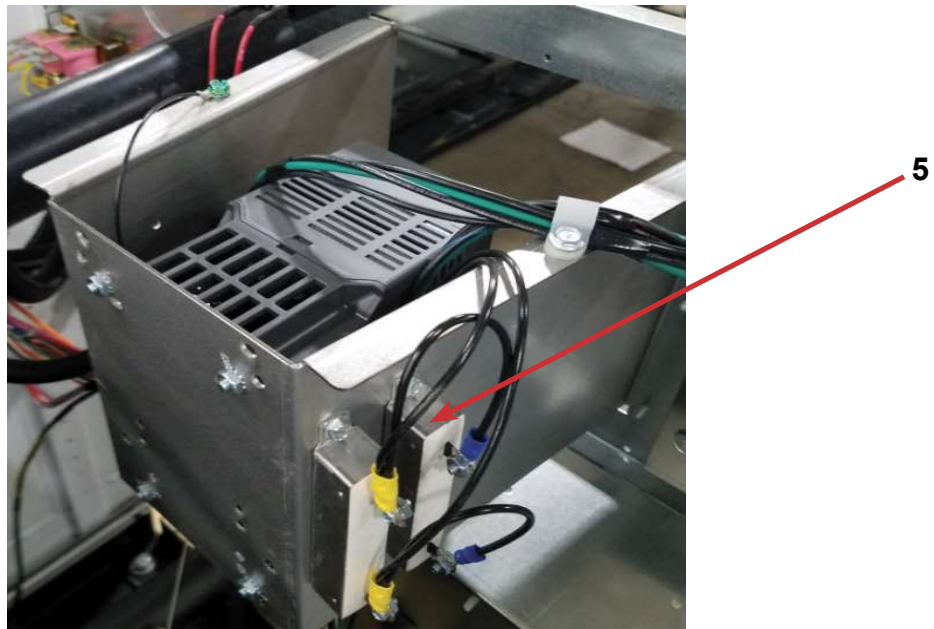
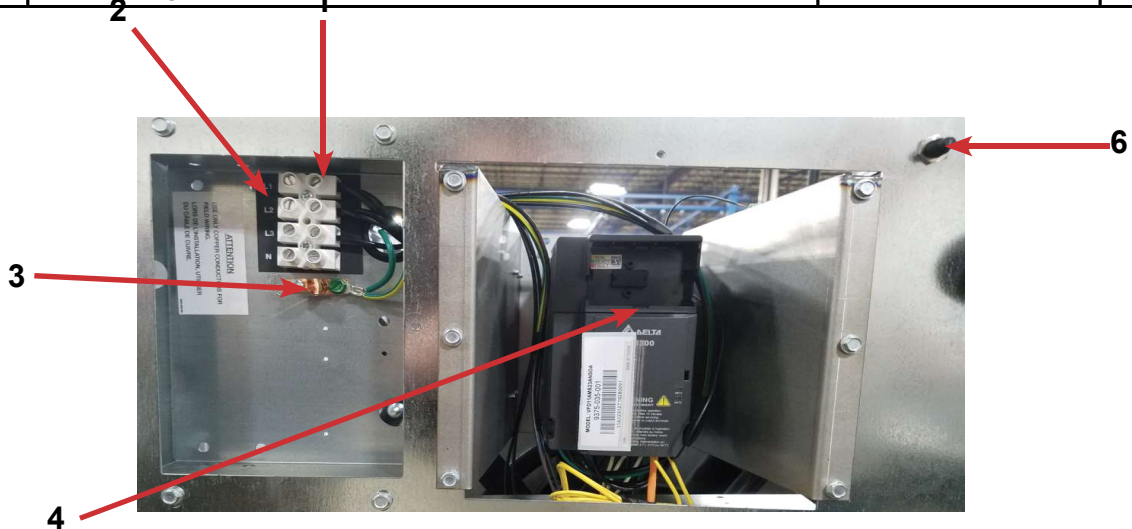

Front Panel Control Group Part

Key	Description	Part Number	Qty
*	Nameplate,Control Panel Blue (one piece)	9412-205-002	1
*	Nameplate,Control Panel Black(one piece)	9412-205-001	1
1	PCB assembly Control /Display	9473-010-001	1
*	Spacer Pushbutton (Micro)	9538-178-001	1
*	Retainer Pushbutton (Micro)	9486-160-001	1
*	Nut Hexelasticstop #4-40	8640-424-002	2
*	Pushbutton Control (coin)	9035-060-003	1
*	Spacer Plastic #6x9/16	9538-157-018	5
*	Nut Elasticstop #6-32	8640-411-002	4
*	Nut-Hexkeys, #6-32	8640-411-003	1
2	Harness LEDPCB	9627-821-001	1
3	Harness Doorlock, Switches	9627-816-002	1
4	PCB assembly Mode lights	9473-005-001	1
*	Spacer Plastic #6x9/16	9537-157-018	2
*	Nut Hexkeys #6-32	8640-411-003	2
5	Switch Assembly Emergency Stop (includes Wire Harness)	9732-223-002	1
*	Spacer Plastic #8x5/16 E-Stop	9538-157-020	2
*	Nut HexKep #8-32 E-Stop	8640-412-005	2
*	Plate to mount e-stop button	9452-725-001	1
6	Door Locking Actuator 24 volts	9892-017-002	1
*	Hex Nuts (mounting gear motor to control)	8640-412-005	4
7	Battery	8612-001-001	1
8	Program-switch	9539-495-001	1
*	Wiring Harness program switch	9627-910-002	1
*	Bracket-Program switch	9029-267-001	1

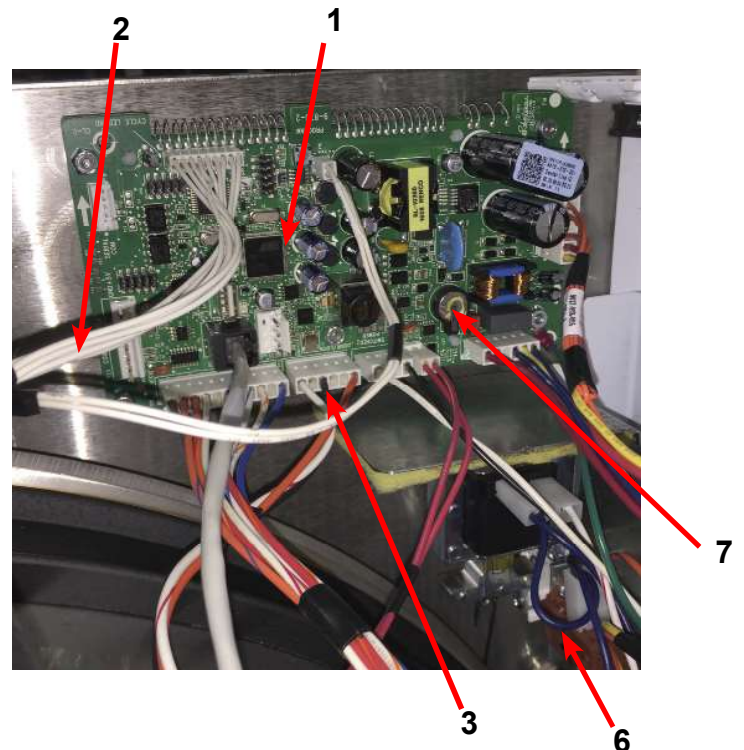
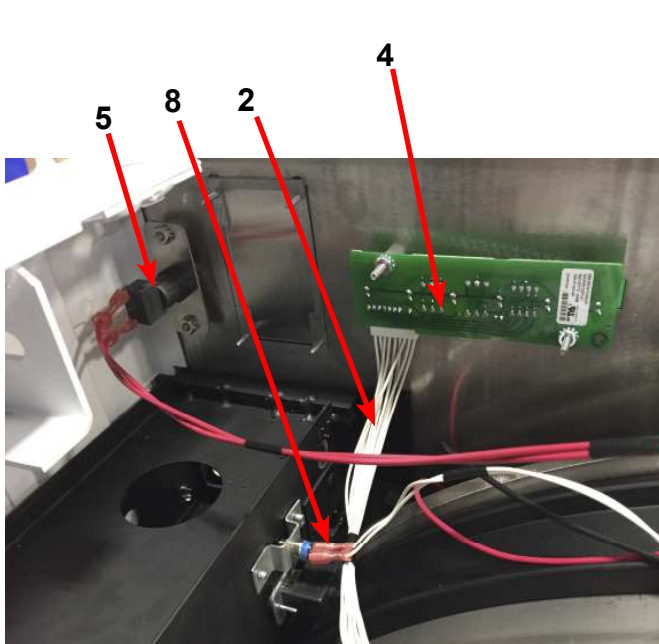

Labels and Diagrams by Part

Key	Description	Part Number	Qty
*	Wiring Diagram, Coin	9506-827-001	1
1	Label High Voltage Warning	8502-614-004	1
*	Cover controls	9074-267-001	1
2	Label Fusing & Installation	8502-619-004	1
3	Label Warning Risk of Injury Blue	8502-759-002	1
*	Label Warning Risk of Injury Black	8502-759-001	1
4	Label Warning Door Opening Blue	8502-757-002	1
*	Label Warning Door Opening Black	8502-757-001	1
*	Booklet Owners	8514-284-001	1
5	Label, Dispenser Instructions, Blue	8502-756-002	1
*	Label, Dispenser Instructions, Black	8502-756-001	1
6	Cover-Motor Control	9074-268-001	1

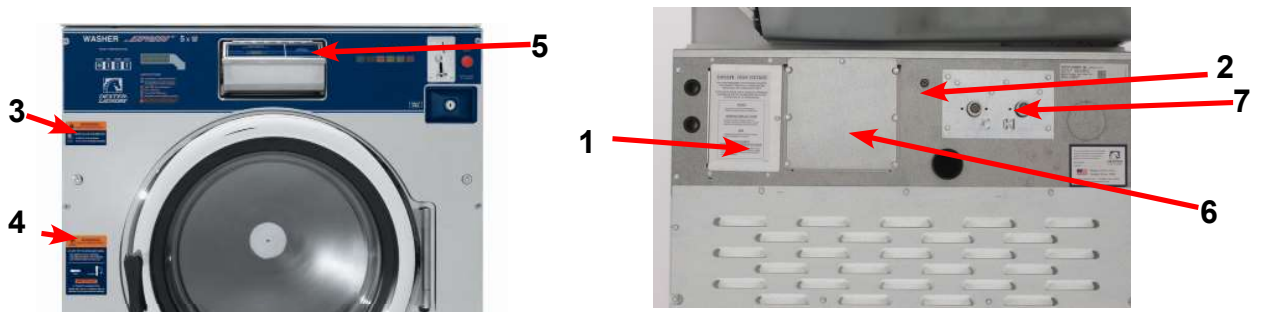

Coin Handling by Part

Key	Description	Part Number	Qty
8	Vault, Assy	9942-028-003	1
*	Screw, 10B x 1/2" Vault Mtg	9545-008-026	4
9	Coin Acceptor Complete (Optical Switch)	9021-094-001	1
*	Screw, Acceptor Mtg	9545-053-002	4
*	Button Coin Return Retainer	9486-145-001	1
*	Harness Coin Switch	9627-916-001	1



Coin Handling Group

Key	Description	Part Number	Qty
	Coin Acceptor, Optical, SWD, US Quarter	9021-094-001	1
*	Harness-Extention ,Control to Acceptor, Optical Dryer	9627-916-001	1
*	Retainer, Coin Acceptor	9486-145-001	1
*	Screw, Torx	9545-053-002	4
1	Switch Assembly, Optical Sensor, SWD	9801-099-003	1
*	Screw-Height Bar, 3mm	9545-039-002	2
	Below not included		
*	Harness, Acceptor Mechanical (Control to Acceptor)	9627-783-003	1
*	Coin Vault	9942-028-003	1
	Screw, 10AB X 1/2	9545-008-024	2

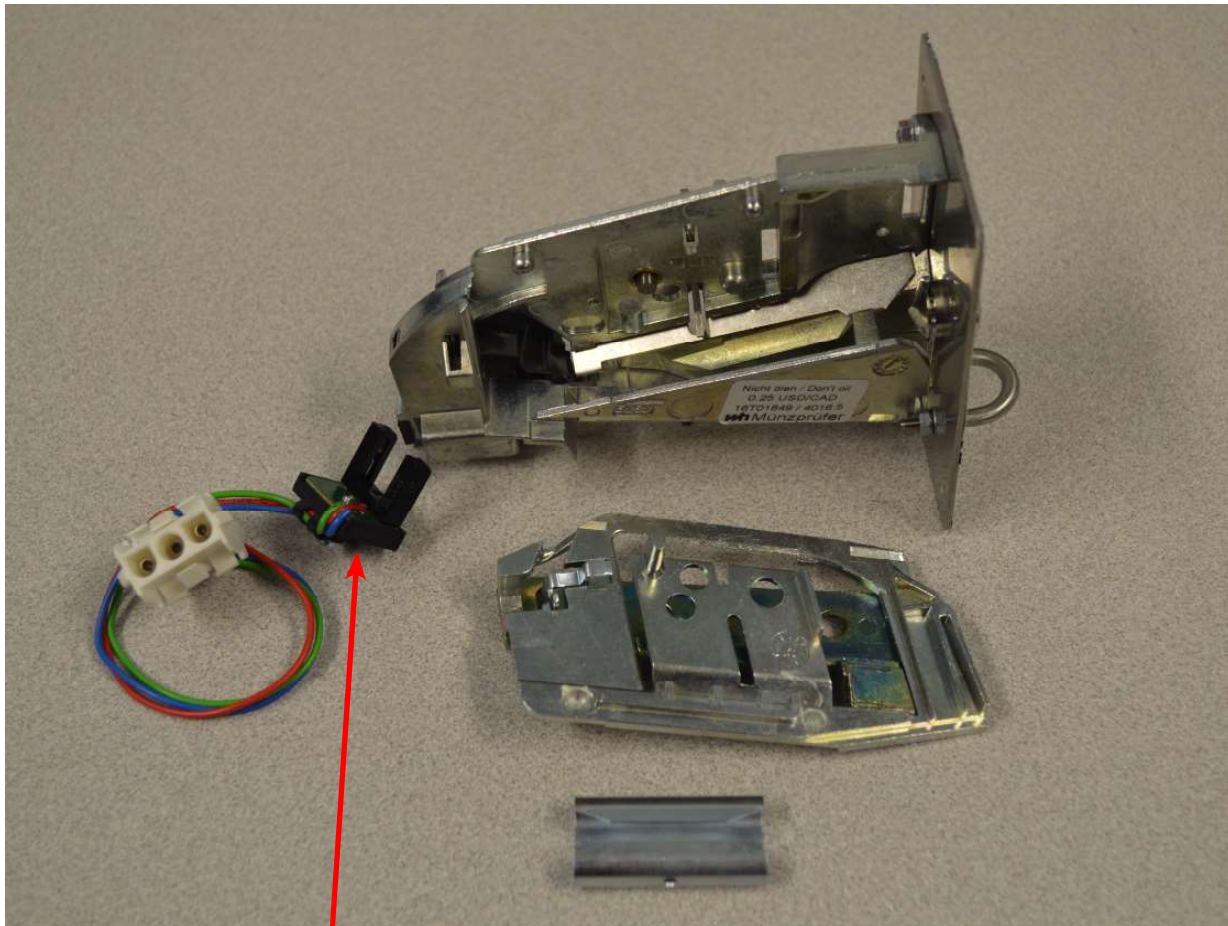

1

Coin Handling Group Electronic

Key	Description	Part Number	Qty
	Kit, Electronic Coin Acceptor	9732-303-004	1
	Acceptor-Electronic, US/CA	9021-054-001	1
	Harness, Control to Acceptor, Dryer	9627-909-003	1
	Harness, Control to Acceptor, Washer	9627-909-002	1
	Lable-Wiring, Electronic Acceptor	8502-730-001	1
	Retainer Coin Acceptor, Electronic	9486-155-001	2
	Screw, 4B x 5/8 ss, Torx T-10	9545-053-002	4
	Below not included		
	Harness, Adaptor Electronic to Mechanical switch	9627-901-001	

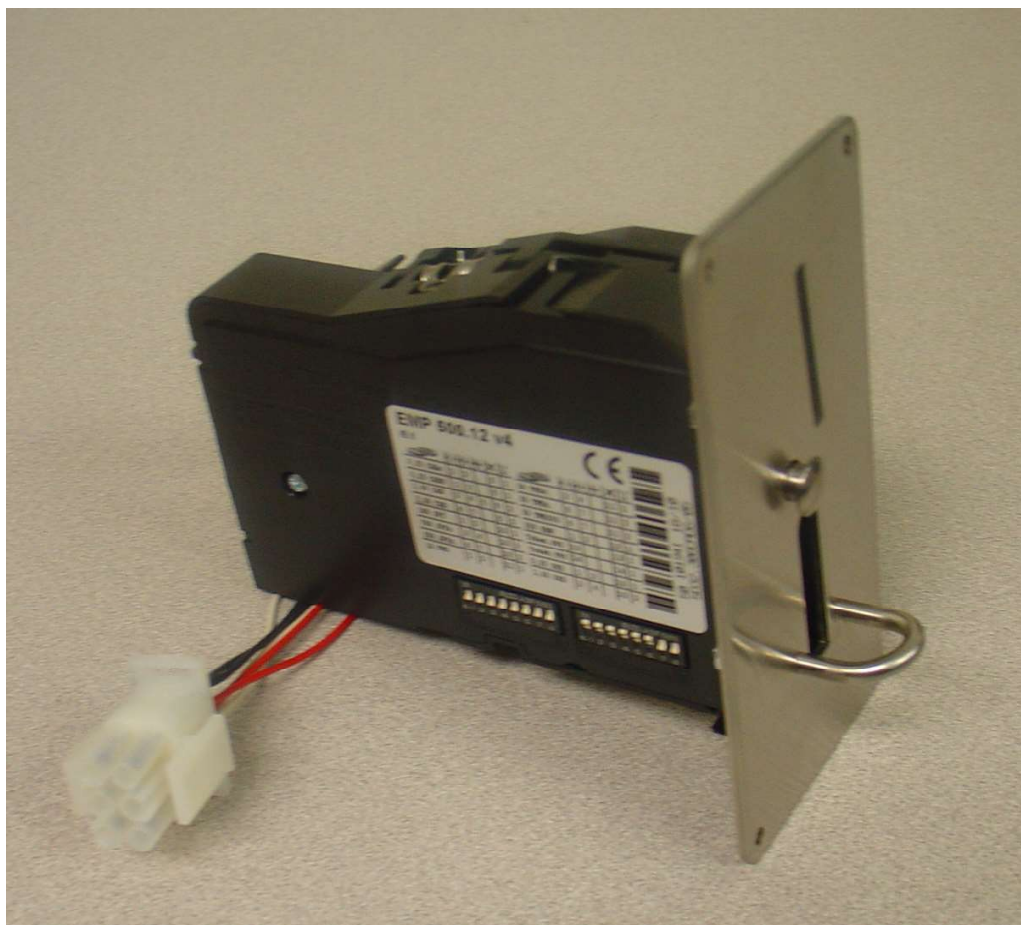

Wiring Schematic for 60hz Coin Washer

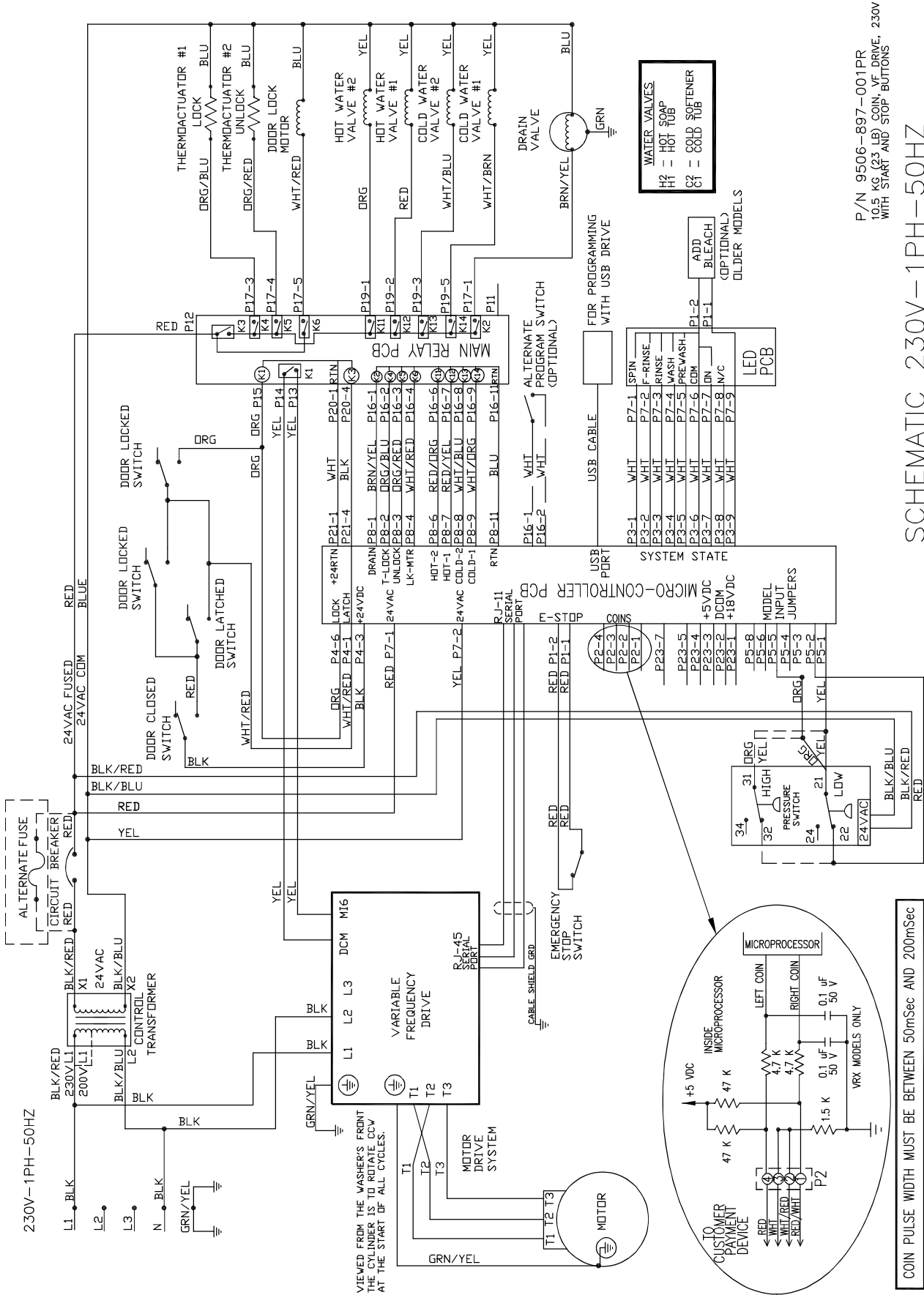

P/N 9506-897-001PR
 10.5 KG (23 LB) COIN W/ DRIVE, 230V
 WITH START AND STOP BUTTONS

SCHEMATIC 230V-1PH-50HZ

Wiring Diagram for 60hz Coin Washer

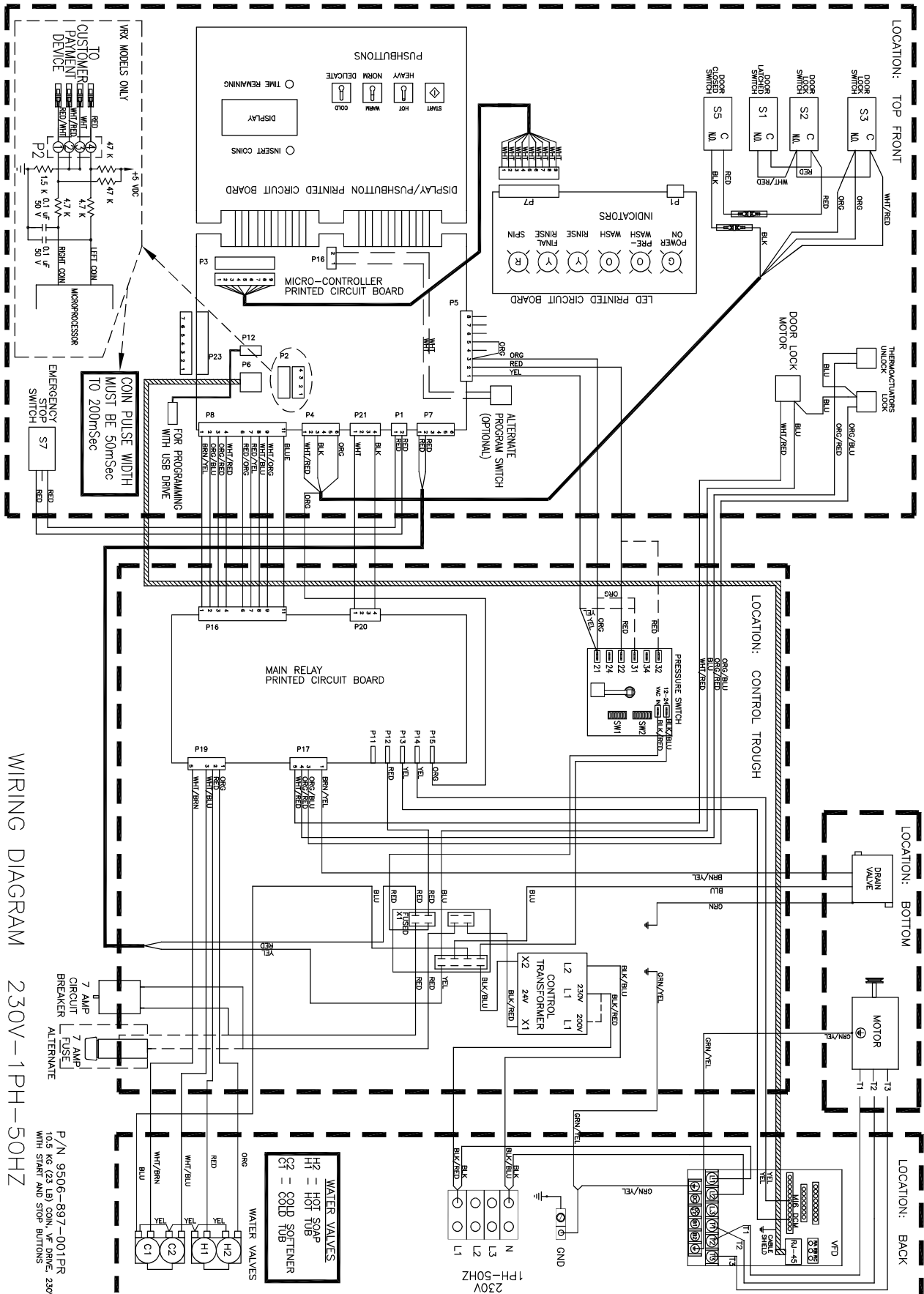

Section 10:

50 Hz Washer

Models

Parts in this section used only in these models. All other parts are same as standard 60 Hz pages.

Coin Handling

KEY	Part Description		QTY
*	Wiringlabel-Diagram/Schematic -39	9506-829-001	1
*	Wiringlabel-Diagram/Schematic -12	9506-827-001	1
1	Elect. Acceptor for C series SWD, Malaysia, Singapore, Thailand	9732-303-001	
	Elect. Acceptor for C series SWD, Swiss, Euro	9732-303-002	
	Elect. Acceptor for C series SWD, Chile, Mexico	9732-303-003	
	Elect. Acceptor for C series SWD, US, CAN	9732-303-004	
	Elect. Acceptor for C series SWD, Japan, Taiwan, Korea	9732-303-005	

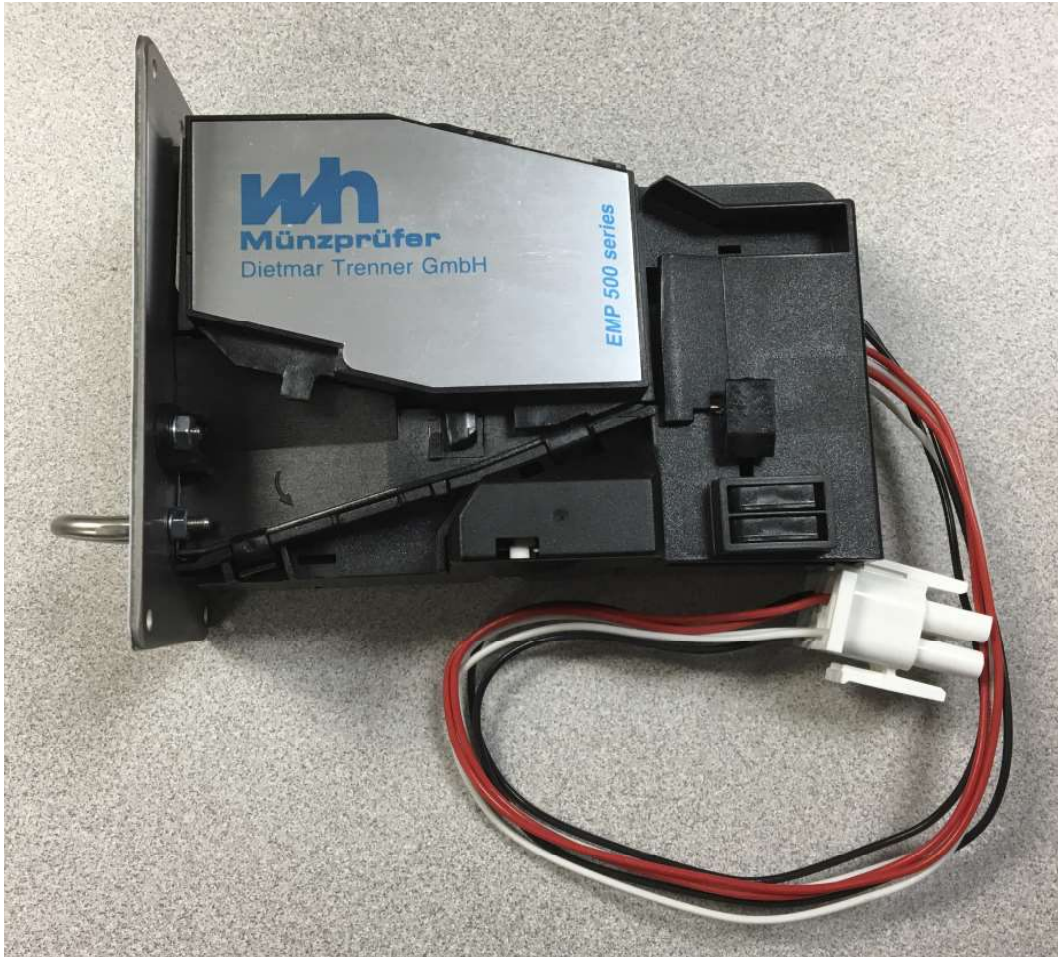

Notes

Lined area for notes.

Wiring Diagram for 50hz Washer -39

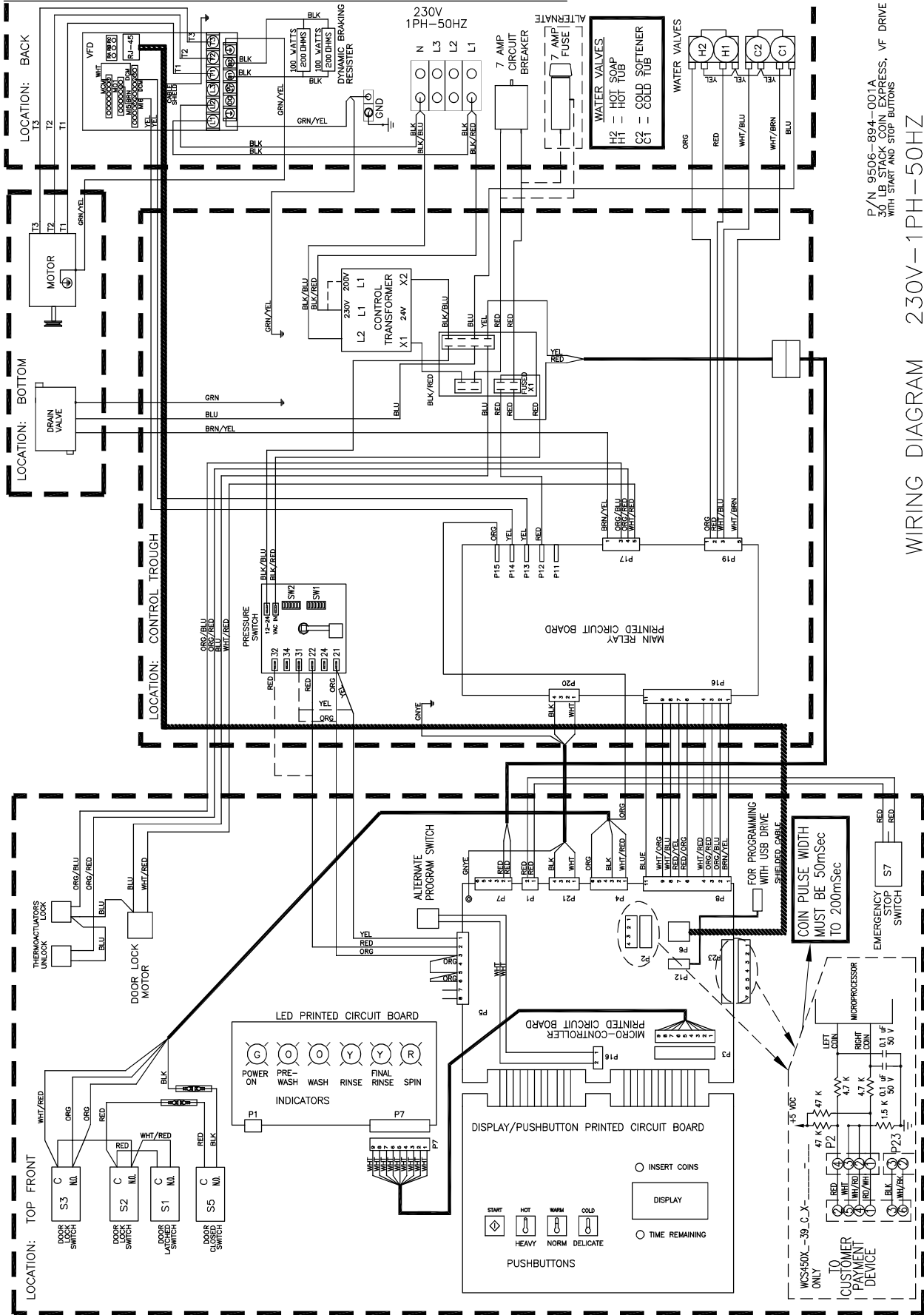

P/N 9506-894-001A
30 LB STACK COIN EXPRESS, VF DRIVE
WITH START AND STOP BUTTONS

WIRING DIAGRAM 230V-1PH-50HZ

Wiring Schematic for 50hz Washer -39

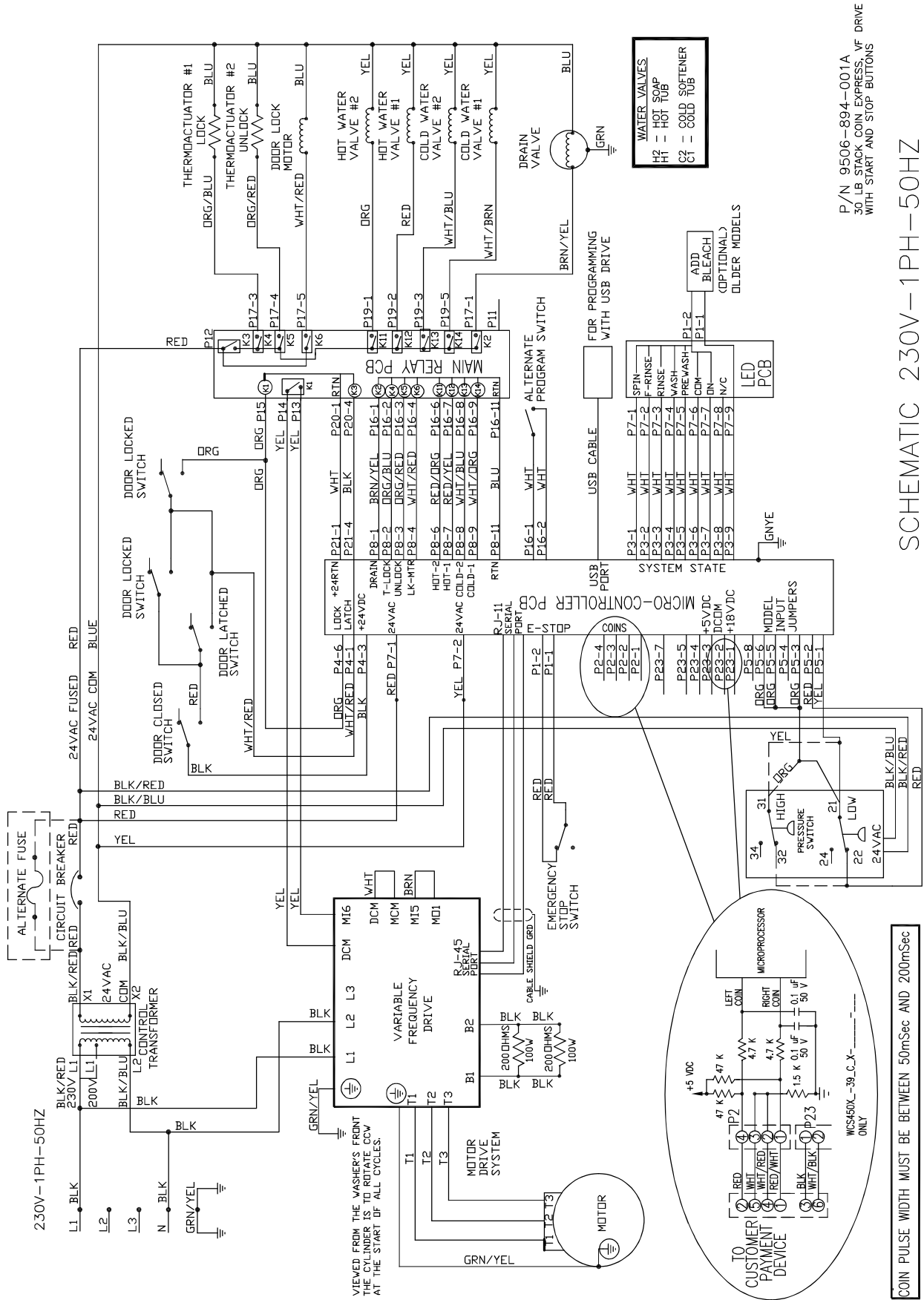

Notes
